



Date
2021-08-04

					2022-02-23 16:10:29		NB8626(44)Ls	A3
		Sheet 1-2	Date					3D



Plan

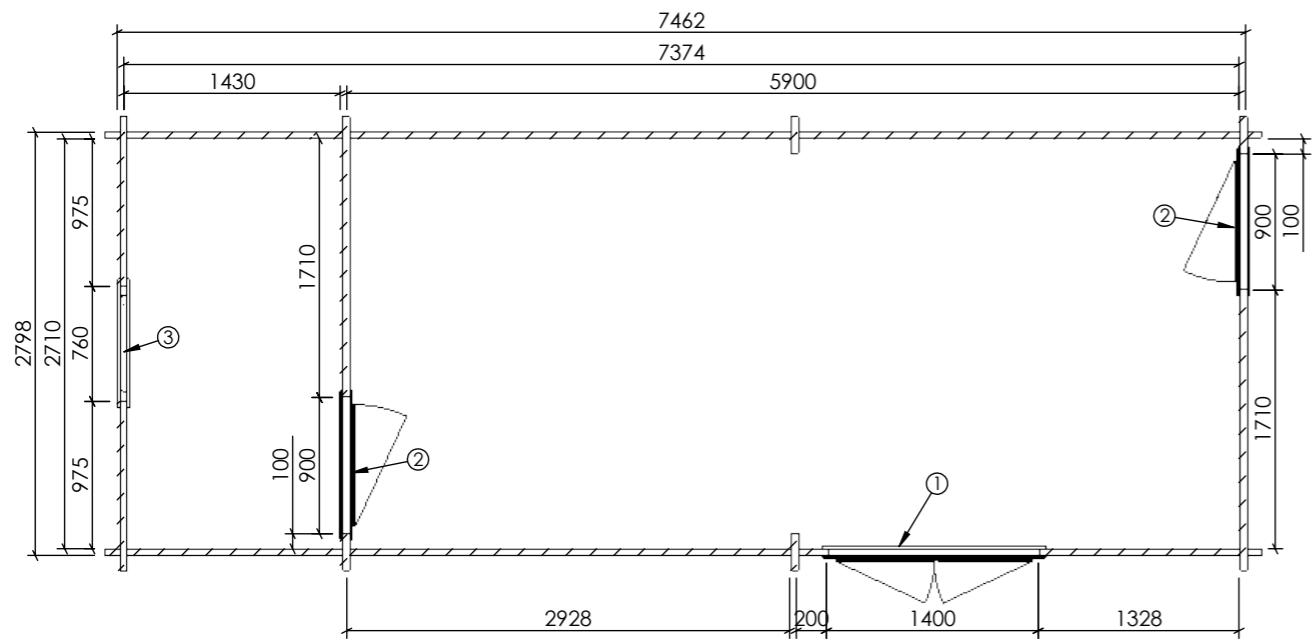
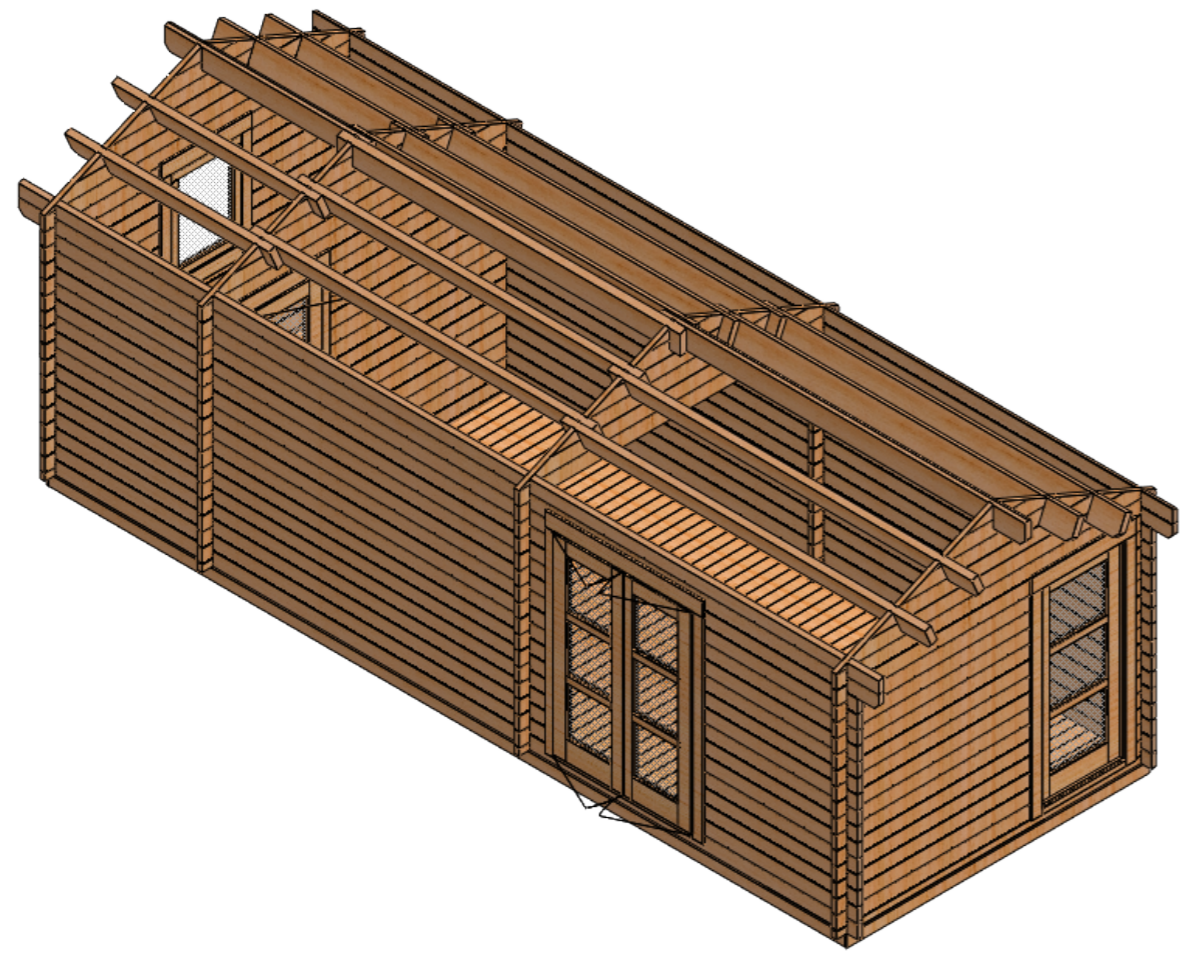
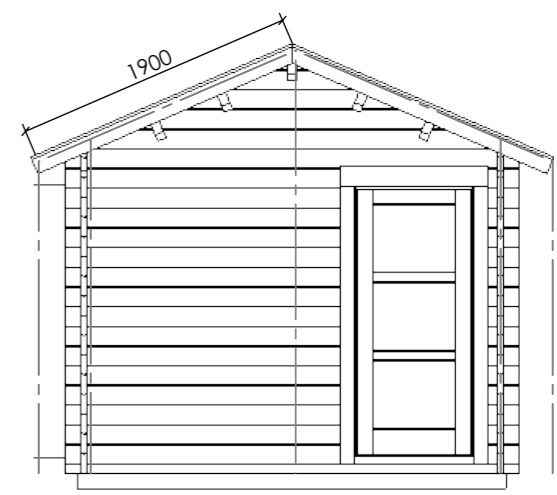
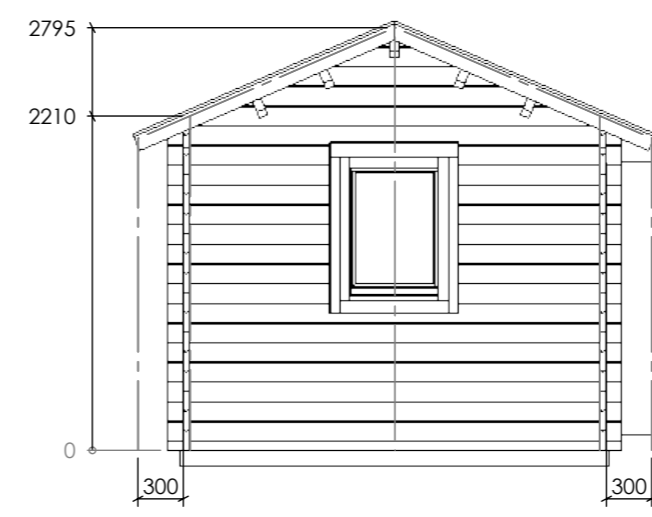
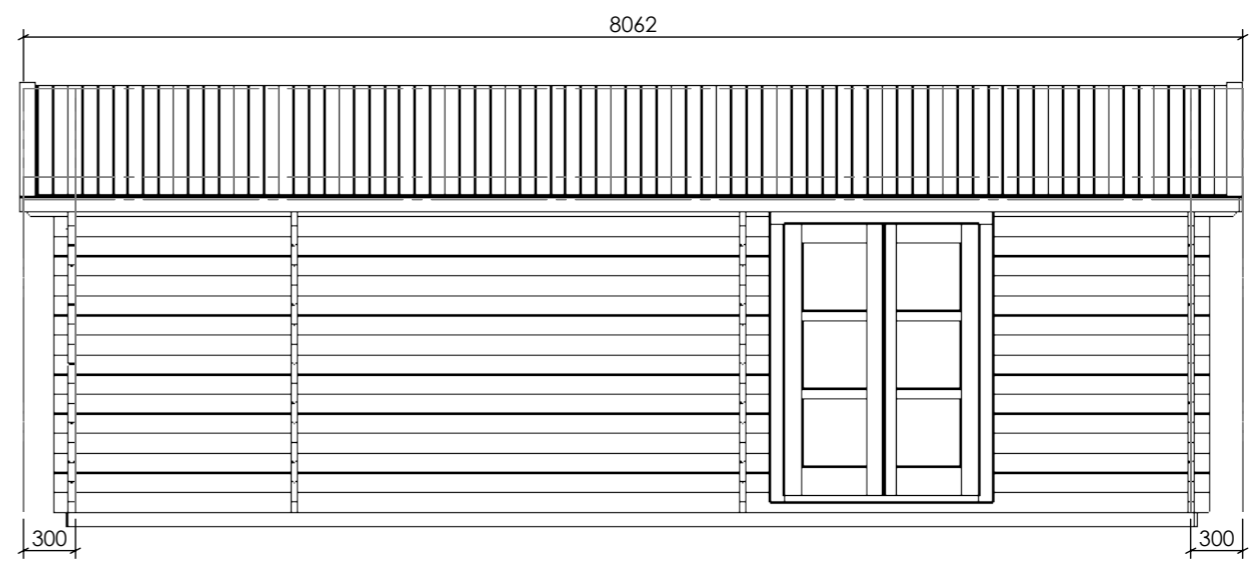

ITEM NO.	DESCRIPTION	QTY.
1	Porte D52 1880x1380	1
2	Porte D52 1880x880	2
3	Fenetre L60, 980x740	1

Date	2021-08-04
------	------------

	Sheet 2-2	Date	2022-02-23 16:10:29	NB8626(44)Ls	A3
					Facades